



34083/**/16

Gebruiksaanwijzing

Notice d'emploi

Benutzerhandbuch

User manual

Manual de usuario

Manual do usuário



PHILIPS

Incl.

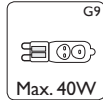
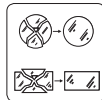
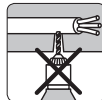
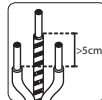
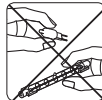
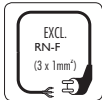
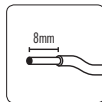
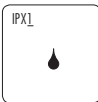
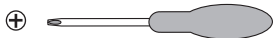
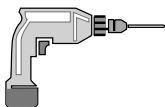
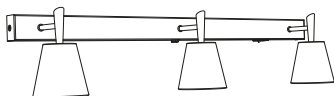

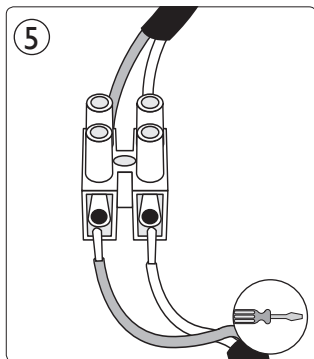
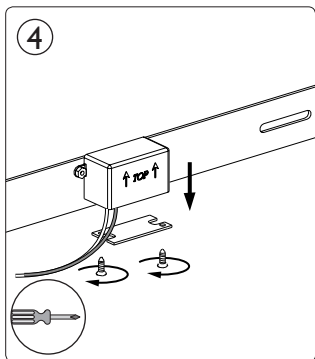
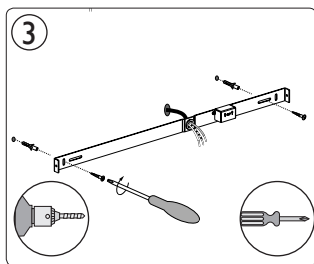
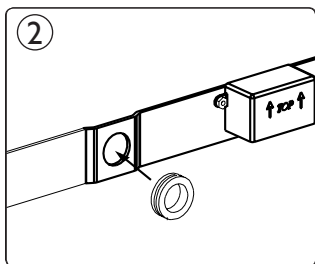
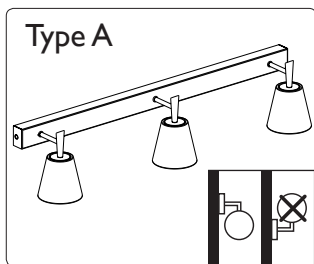
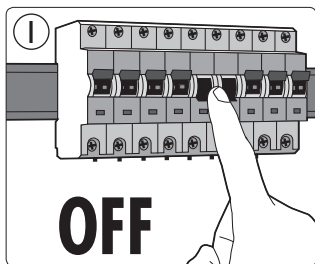

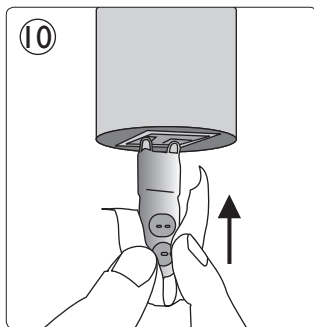
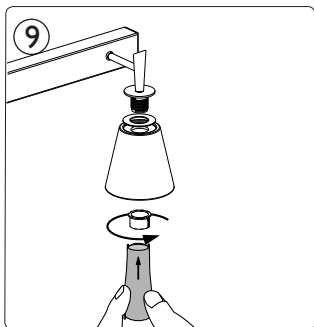
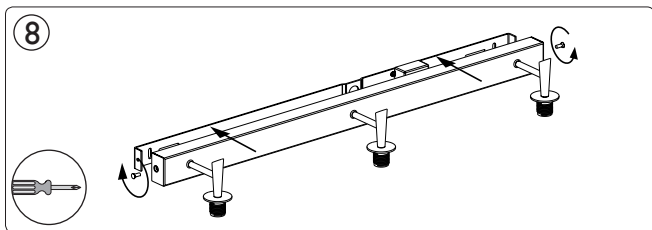
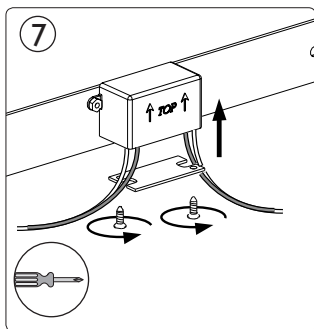
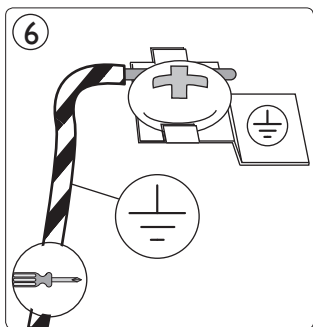

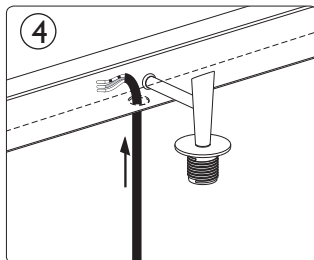
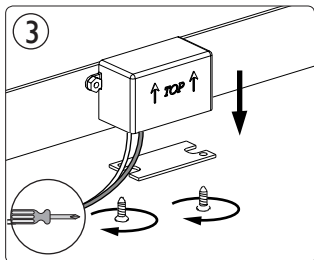
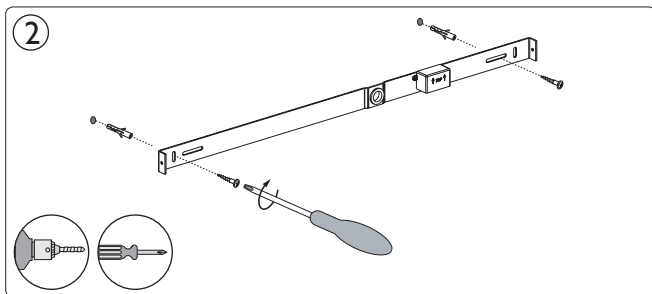
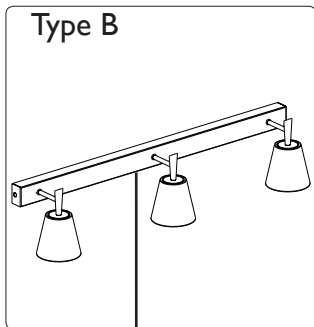
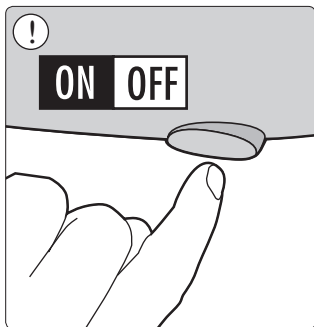

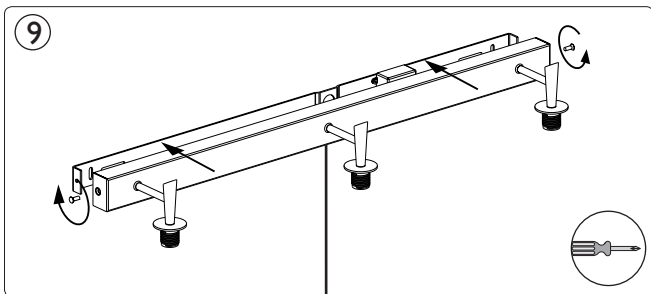
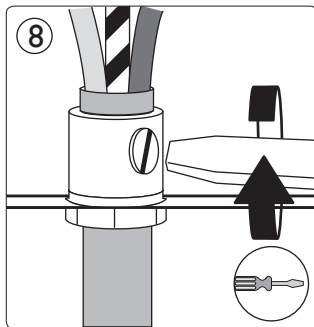
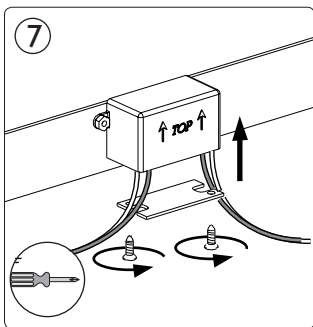
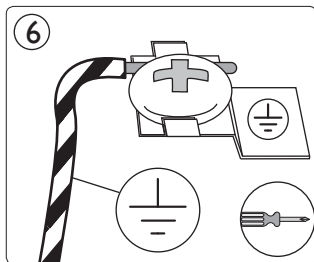
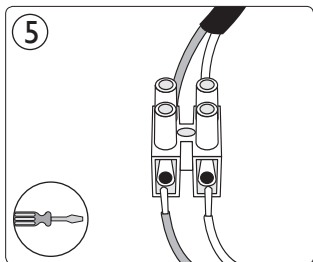

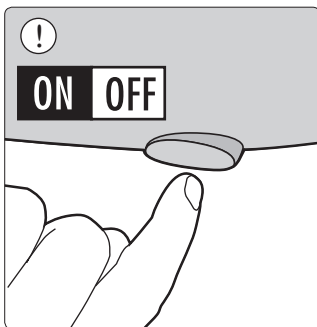
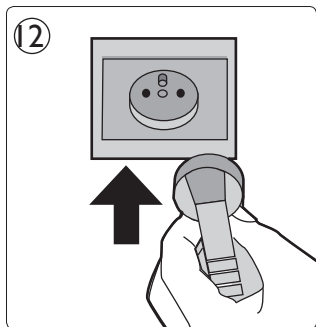
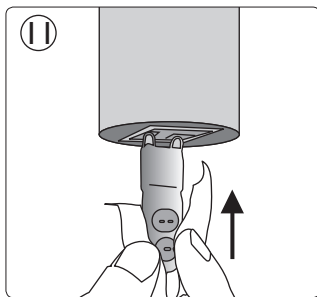
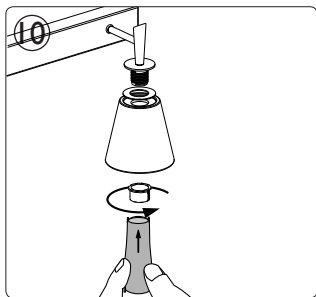



Philips Lighting Contact Centre
Int. Business Reply Service
I.B.R.S. / C.C.R.I. Numéro 10461
5600 VB Eindhoven
Pays-Bas / The Netherlands

www.philips.com/homelighting
☎ +800 7445 4775

4404.018.34951
Last update: 23/01/13